

Please write clearly in block capitals.

Centre number

--	--	--	--	--

Candidate number

--	--	--	--

Surname

Forename(s)

Candidate signature

I declare this is my own work.

GCSE MATHEMATICS

H

Higher Tier

Paper 2 Calculator

Thursday 3 November 2022

Morning

Time allowed: 1 hour 30 minutes

Materials

For this paper you must have:

- a calculator
- mathematical instruments
- the Formulae Sheet (enclosed).

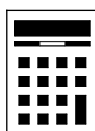

Instructions

- Use black ink or black ball-point pen. Draw diagrams in pencil.
- Fill in the boxes at the top of this page.
- Answer **all** questions.
- You must answer the questions in the spaces provided. Do not write outside the box around each page or on blank pages.
- If you need extra space for your answer(s), use the lined pages at the end of this book. Write the question number against your answer(s).
- Do all rough work in this book. Cross through any work you do not want to be marked.

Information

- The marks for questions are shown in brackets.
- The maximum mark for this paper is 80.
- You may ask for more answer paper, graph paper and tracing paper. These must be tagged securely to this answer book.

For Examiner's Use	
Pages	Mark
2–3	
4–5	
6–7	
8–9	
10–11	
12–13	
14–15	
16–17	
18–19	
20–21	
22–23	
24	
TOTAL	

Advice

In all calculations, show clearly how you work out your answer.



N 0 V 2 2 8 3 0 0 2 H 0 1

Answer **all** questions in the spaces provided.

1 Work out $\frac{4^6 - 11}{\sqrt{625} - 225}$

Circle your answer.

[1 mark]

-61.6

-20.425

204.25

3870.56

2 Work out $(3.1 \times 10^9)^2$

Circle your answer.

[1 mark] 6.2×10^{18} 6.2×10^{81} 9.61×10^{18} 9.61×10^{81}

3 The equation of a line is $y = 3x - 6$

Circle the coordinates of the y -intercept.**[1 mark]**

(0, -6)

(-6, 0)

(0, 3)

(3, 0)



4 $a \times b^4 = c$

Circle the correct expression for a .

[1 mark]

$$\frac{c}{\sqrt[4]{b}}$$

$$\frac{c}{b^{-4}}$$

$$\left(\frac{c}{b}\right)^4$$

$$\frac{c}{b^4}$$

5 Written as the product of prime factors,

$$12\,600 = 2^3 \times 3^2 \times 5^2 \times 7$$

and

$$14\,112 = 2^5 \times 3^2 \times 7^2$$

Work out the highest common factor (HCF) of 12 600 and 14 112

Give your answer as an integer.

[2 marks]

Answer _____



- 6 The composite bar chart shows information about the **percentage** of drinks sold by a café in 2007 and 2019

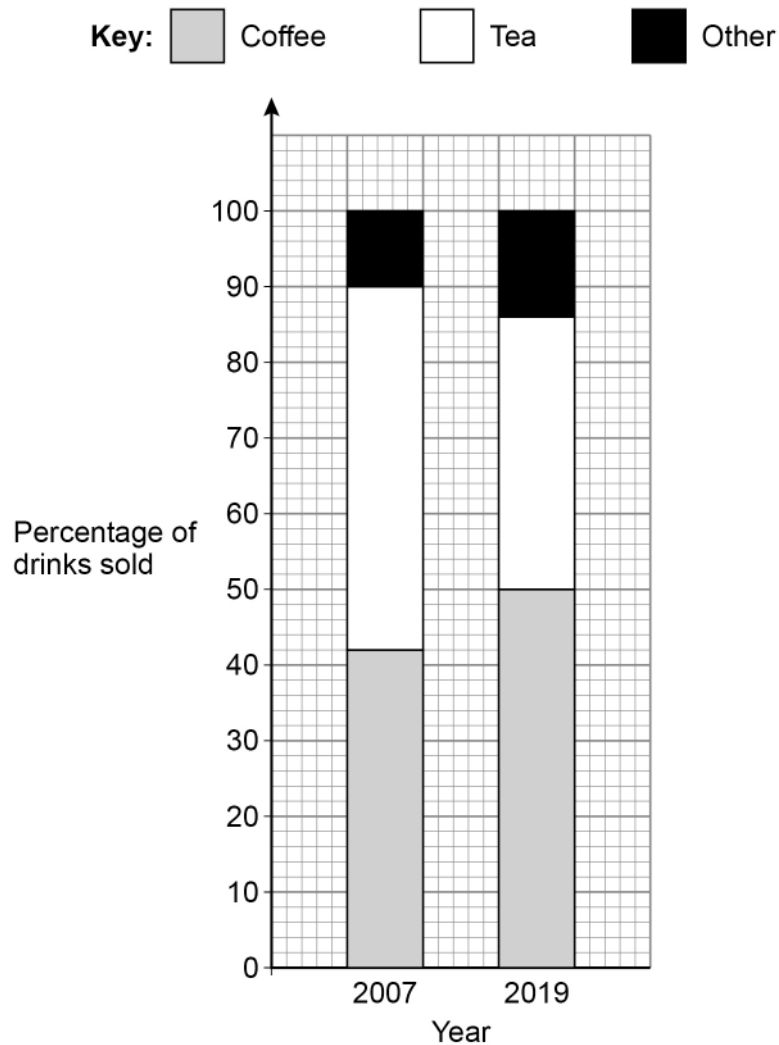

- 6 (a) In 2007 the café sold a total of 24 000 drinks.
How many **more** teas than coffees were sold?

[2 marks]

Answer _____



6 (b) Were more coffees sold at the café in 2019 than in 2007 ?

Tick a box.

Yes

No

Cannot tell

Give a reason for your answer.

[1 mark]

7 (a) k is a whole number between 40 and 50

The cube root of k is 3, to the nearest whole number.

Work out the **largest** possible value of k .

[2 marks]

Answer _____

7 (b) Fay tries to solve $x^2 = 100$

She says,

“The only possible value of x is 10”

Give a reason why she is **not** correct.

[1 mark]



- 8 (a) Here is a cuboid.
 w , x and y are **different** whole numbers.

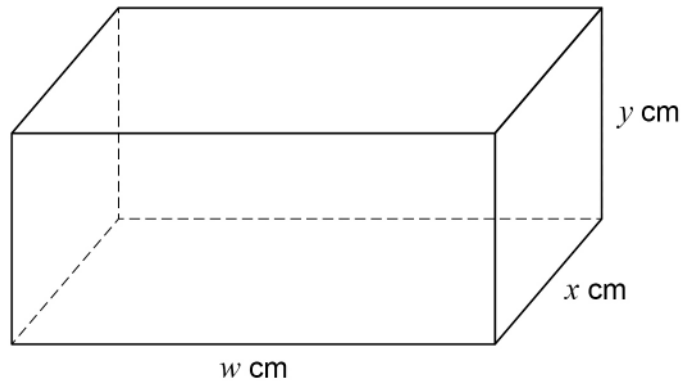

The total length of **all** the edges of the cuboid is 80 cm

The volume is **greater** than 200 cm^3

Work out one possible set of values for w , x and y .

[2 marks]

$w =$ _____ $x =$ _____ $y =$ _____



- 8 (b) Here is a solid cube.

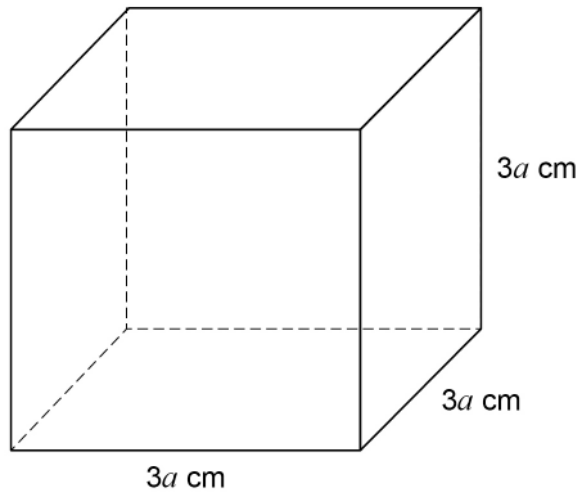

Circle the expression for the **total** surface area in cm^2

[1 mark]

$36a$

$54a$

$36a^2$

$54a^2$

- 9 The 47th triangular number is 1128
The 48th triangular number is 1176
Work out the 49th triangular number.

[1 mark]

Answer _____



- 10** The n th terms of two linear sequences, A and B, are added to give the n th term of a new sequence.

The new sequence starts

8 13 18 23

The n th term of sequence A is $n + 1$

Work out the n th term of sequence B.

[4 marks]

Answer _____

- 11** A tank contains 40 litres of water.

- 11 (a)** Water leaks out of the tank at a rate of 1.2 litres per minute.

The leak is stopped after 20 minutes.

Show that, when the leak is stopped, the tank contains 16 litres of water.

[1 mark]



- 11 (b)** The tank is refilled with water from a tap.
The graph shows the amount of water in the tank **after** the leak is stopped.

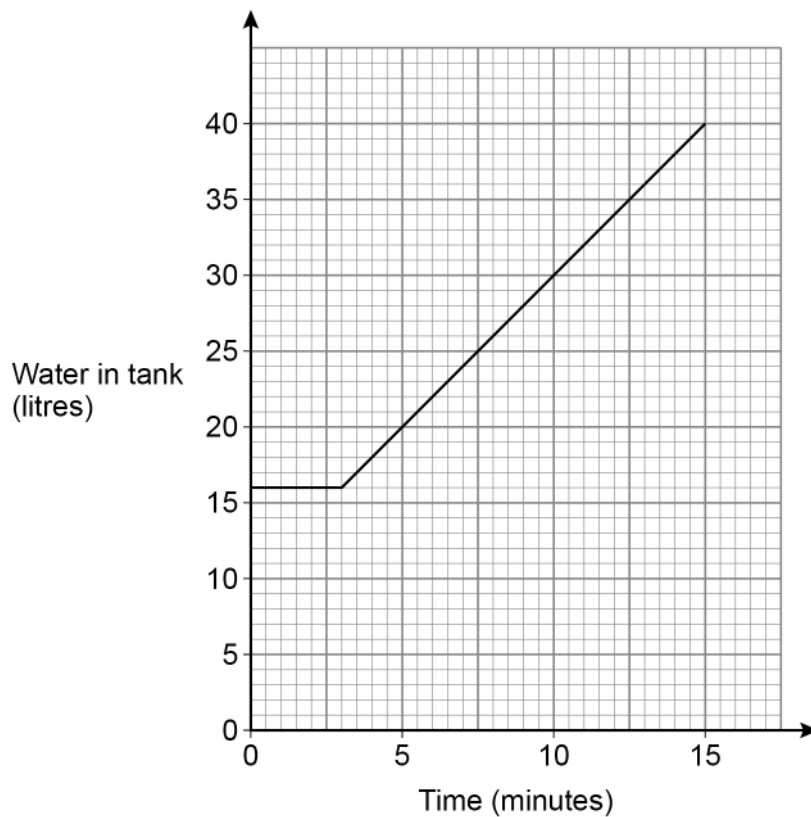

Complete this report by writing a number in each answer space.

[3 marks]

Report

_____ minutes after the leak is stopped, the tap starts to refill the tank.

The rate at which the tank refills is _____ litres per minute.

Turn over ►



- 12 The length of this rectangle is 6 times the width.

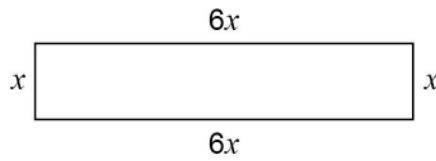

Not drawn
accurately

Two of these rectangles are joined, with no overlap, to make this L-shape.

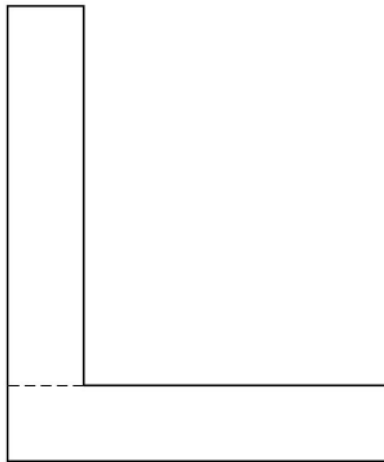

Not drawn
accurately

The perimeter of the L-shape is 98.8 cm

Work out the value of the perimeter of **one** of the rectangles.

[4 marks]

Answer _____ cm



- 16 Here is a sketch of a graph.

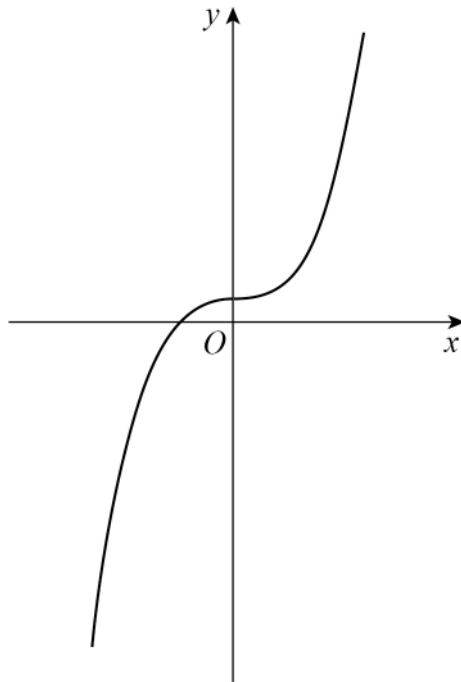

Circle the possible equation of the graph.

[1 mark]

$$y = x^2 + 1 \quad y = \frac{1}{x} + 1 \quad y = x^3 + 1 \quad y = 1 - x^2$$

- 17 A sequence of numbers is formed by the iterative process

$$u_{n+1} = \frac{20}{u_n + 3} \quad \text{where} \quad u_1 = 1$$

Work out u_3

Circle your answer.

[1 mark]

$$\frac{40}{11}$$

$$\frac{5}{2}$$

7

5



- 18** A basketball team plays 19 home games and 19 away games.
The box plot shows information about the points the team scored in **home** games.

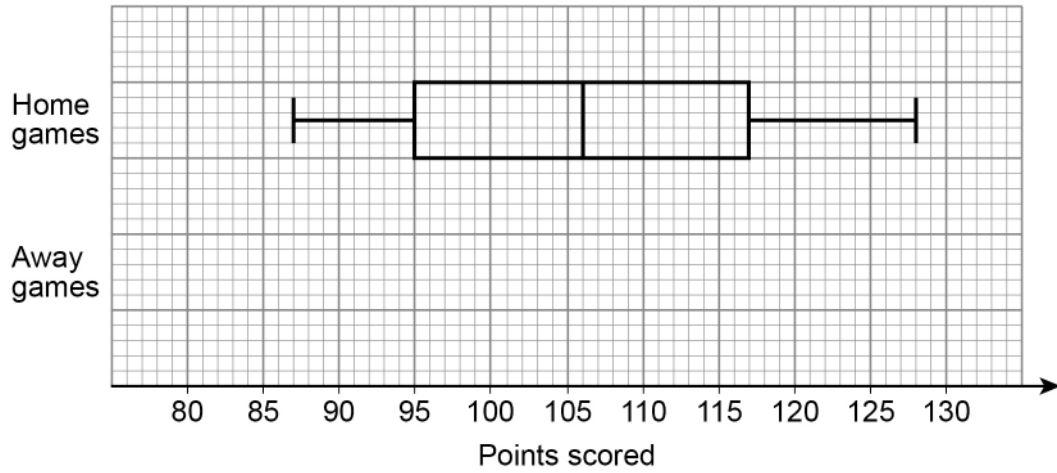

Here are the points the team scored in the 19 **away** games.

85 89 93 95 96 96 98 98 98 99
100 103 105 107 109 110 114 119 126

- 18 (a)** On the grid, draw a box plot for the away games.

[4 marks]



- 18 (b)** On average, did the team score more points in home games or away games?
Use **one** statistical measure to support your decision.

[1 mark]

- 18 (c)** Was the number of points scored more consistent in home games or away games?
Use **one** statistical measure to support your decision.

[1 mark]

- 19** Using the quadratic formula, or otherwise, solve $3x^2 + x - 5 = 0$

[2 marks]

Answer _____



20

A vending machine has a different item in each section.

It sells

7 drinks, 3 of which are juice

5 snacks, 2 of which are fruit bars

11 meals, 4 of which are salad.

One drink, one snack and one meal are chosen at random.

Show that the probability of getting a juice, a fruit bar and a salad is **more** than 5%

[3 marks]



21 $f(x) = \frac{3x+9}{5}$ and $g(x) = 6x - 1$

21 (a) Show that $gf(2)$ is an integer.

[2 marks]

21 (b) Show that $f^{-1}(8)$ is **not** an integer.

[2 marks]



22 Factorise fully $x^3 - 49x$

[2 marks]

Answer _____

23 61 students recorded how many hours they spent revising for a test.
The histogram represents the results.

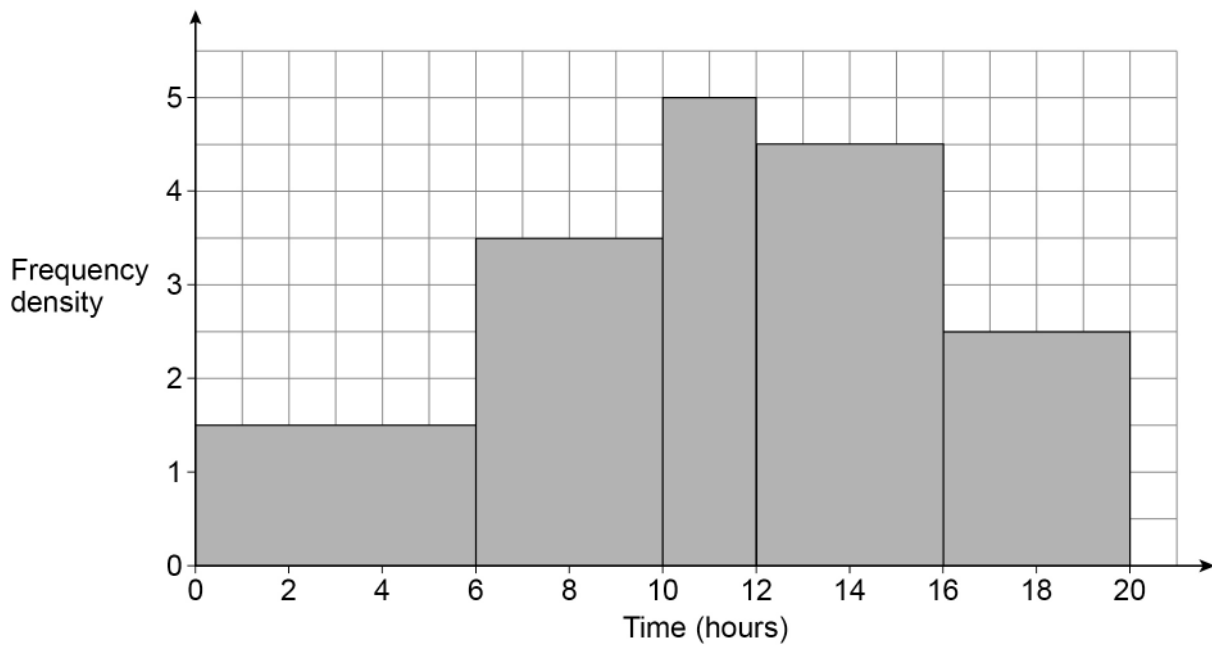

- 23 (a)** Work out an estimate of the mean time the 61 students spent revising.
You may use the table to help you.

[4 marks]

Time, x (hours)	Frequency	Midpoint	
$0 \leq x < 6$			
$6 \leq x < 10$			
$10 \leq x < 12$			
$12 \leq x < 16$			
$16 \leq x < 20$			

Answer _____ hours

- 23 (b)** Give a reason why the answer to part (a) is an estimate.

[1 mark]

Turn over ►

24

B is 60 miles from A on a bearing of 170°

Not drawn accurately

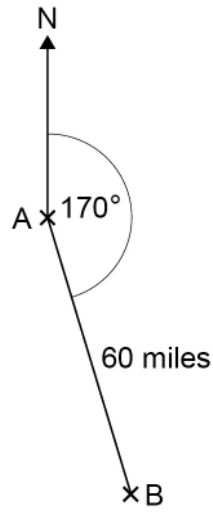

A ship sails from A on a bearing of 247°

It travels at a constant speed of 23 mph for $1\frac{1}{2}$ hours.

Is the ship now closer to B than it was when it left A?

You **must** show your working.

[5 marks]

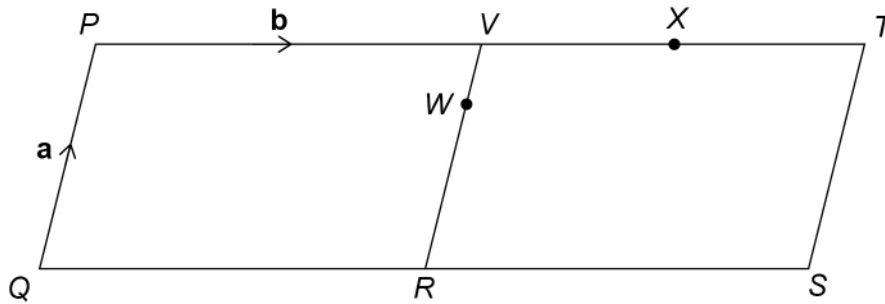

25

Two congruent parallelograms, $PQRV$ and $VRST$, are joined.Not drawn
accurately

$$\overrightarrow{QP} = \mathbf{a} \quad \overrightarrow{PV} = \mathbf{b}$$

X is the midpoint of VT .

$$VW : WR = 1 : 2$$

Prove that Q , W and X lie on a straight line.

[3 marks]

Turn over ►



26

Helena ran an 800-metre race in 140 seconds.

The speed-time graph represents the first 100 seconds of her run.

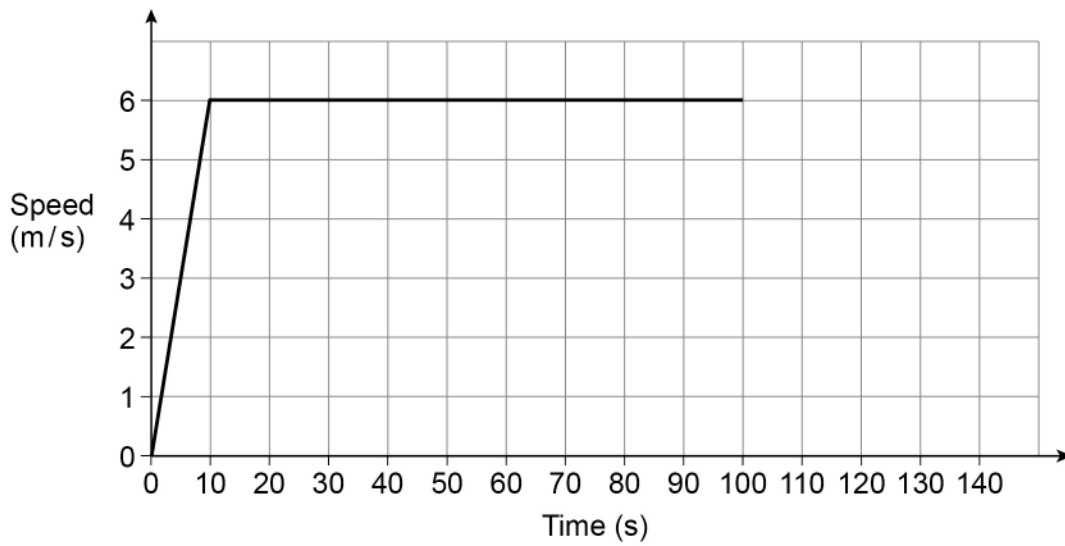

Helena ran the last 40 seconds with constant deceleration.

Work out her speed as she finished the race.

[4 marks]

Answer _____ metres per second



27

In a class there are
 n boys
a total of 25 students.

Two of the students are chosen at random.

The probability that both students are boys is $\frac{7}{20}$

Work out the value of n .

[4 marks]

$n =$ _____

8

Turn over ►

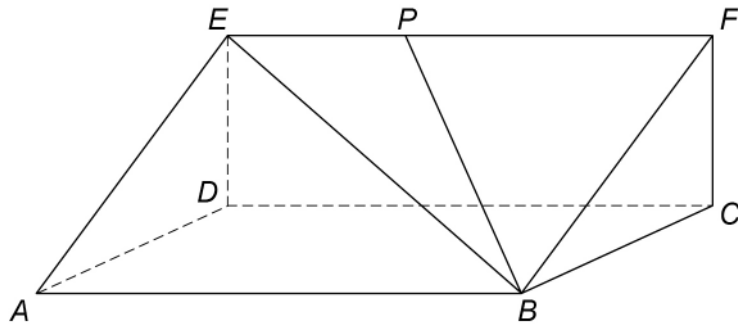

28

 $ABCDEF$ is a triangular prism. P is a point on EF .

$$EB = 29 \text{ cm}$$

$$\text{Angle } EBP = 35^\circ$$

$$\text{Angle } EPB = 114^\circ$$

Work out the length of EP .**[2 marks]**

Answer _____ cm

END OF QUESTIONS

2



There are no questions printed on this page

*Do not write
outside the
box*

**DO NOT WRITE ON THIS PAGE
ANSWER IN THE SPACES PROVIDED**



