

Tuesday 11 June 2019 – Morning

GCSE (9–1) Mathematics

J560/03 Paper 3 (Foundation Tier)

Time allowed: 1 hour 30 minutes



You may use:

- a scientific or graphical calculator
- geometrical instruments
- tracing paper



Please write clearly in black ink. **Do not write in the barcodes.**

Centre number

--	--	--	--	--

Candidate number

--	--	--	--

First name(s)

Last name

INSTRUCTIONS

- Use black ink. You may use an HB pencil for graphs and diagrams.
- Answer **all** the questions.
- Read each question carefully before you start your answer.
- Where appropriate, your answers should be supported with working. Marks may be given for a correct method even if the answer is incorrect.
- Write your answer to each question in the space provided. Additional paper may be used if required but you must clearly show your candidate number, centre number and question number(s).

INFORMATION

- The total mark for this paper is **100**.
- The marks for each question are shown in brackets [].
- Use the π button on your calculator or take π to be 3.142 unless the question says otherwise.
- This document consists of **24** pages.

Answer **all** the questions.

- 1 (a) Write down the mathematical name of this type of angle.
Choose from the list in the box.

acute	reflex	obtuse	right angle
-------	--------	--------	-------------

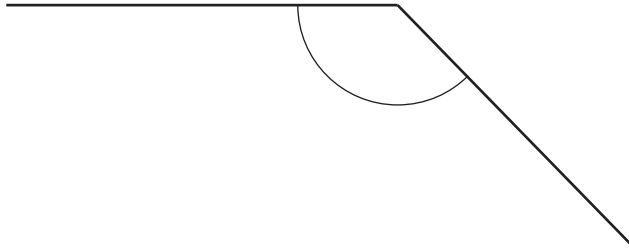

(a) [1]

- (b) Measure angle *g*.

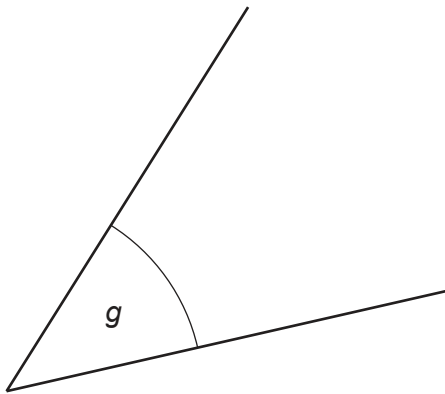

(b) ° [1]

2 (a) Write 6 : 14 as a ratio in its simplest form.

(a) : [1]

(b) The ratio 20 : 50 can be written in the form 1 : n .

Find the value of n .

(b) $n =$ [2]

3 Insert brackets to make each of these calculations correct.

$$5 \times 3 - 1 = 10$$

$$3 + 6 - 2 \div 2 = 3.5$$

[2]

4 Work out 20% of 40.

..... [2]

5 A shape is drawn on a one-centimetre grid.

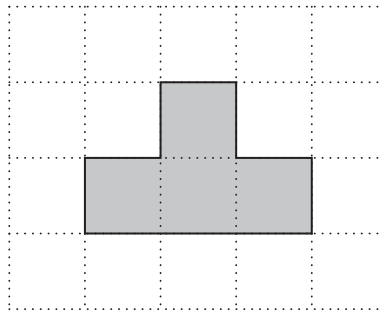

(a) Find the perimeter of the shape.

(a) cm [1]

(b) How many lines of symmetry does the shape have?

(b) [1]

6 (a) These are the first five multiples of 15.

15 30 45 60 75

Write down the first five multiples of 30.

(a) , , , , [2]

(b) Write down the lowest common multiple (LCM) of 15 and 30.

(b) [1]

7 Point P is shown on this grid.

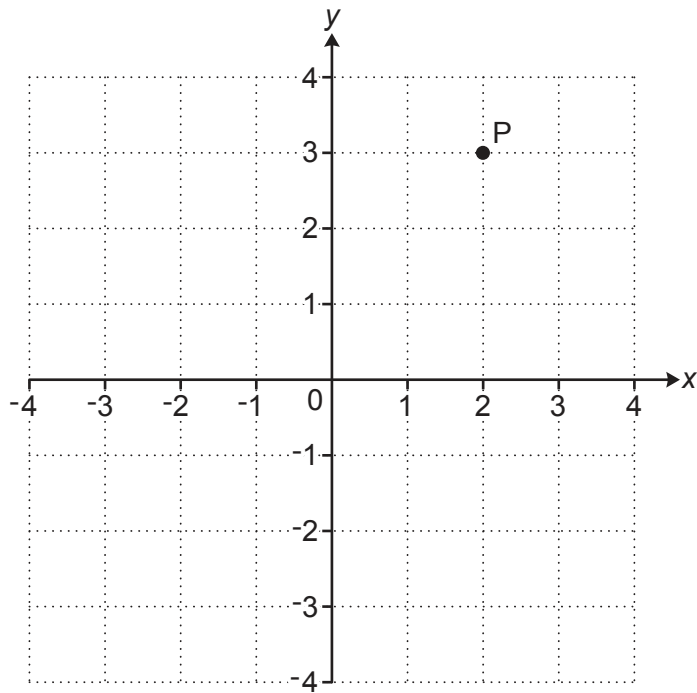

(a) Write down the coordinates of point P.

(a) (.....,) [1]

(b) Draw the line $x = -2$ on the grid.

[1]

8 Find the value of $3g - h$ when $g = 4$ and $h = 5$.

..... [2]

9 Here are the first three patterns in a sequence.

Pattern 1



Pattern 2



Pattern 3



(a) Draw Pattern 4 in the sequence.

Pattern 4

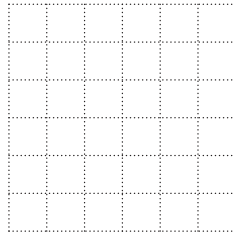

[1]

(b) Without drawing it, work out how many dots there are in Pattern 8.
Explain how you decide.

..... dots because

.....

..... [2]

(c) Pattern n has 196 dots.

Find the value of n .

(c) $n =$ [1]

10 The pie chart shows how Jack spent his time one evening.

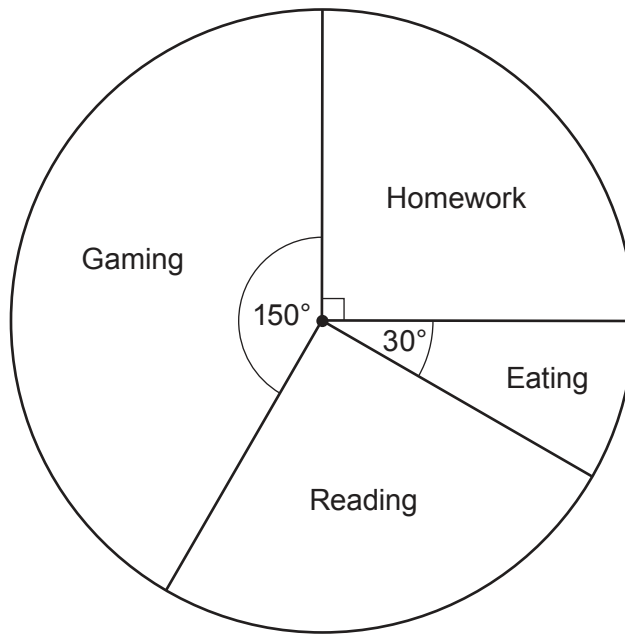

(a) On which activity did Jack spend most time?

(a) [1]

(b) Jack says

I spent $\frac{1}{3}$ of my time on *Gaming*.

Show that he is not correct.

..... [2]

(c) The pie chart represents 5 hours.

Find the time, in hours and minutes, that Jack spent reading.

(c) h min [4]

- 11 Megan's Cafe sells ice cream. Customers choose to have a tub or a cone, and a wafer or no wafer. They can choose vanilla, lemon or chocolate ice cream.

This frequency tree shows the number of people making some of the choices.

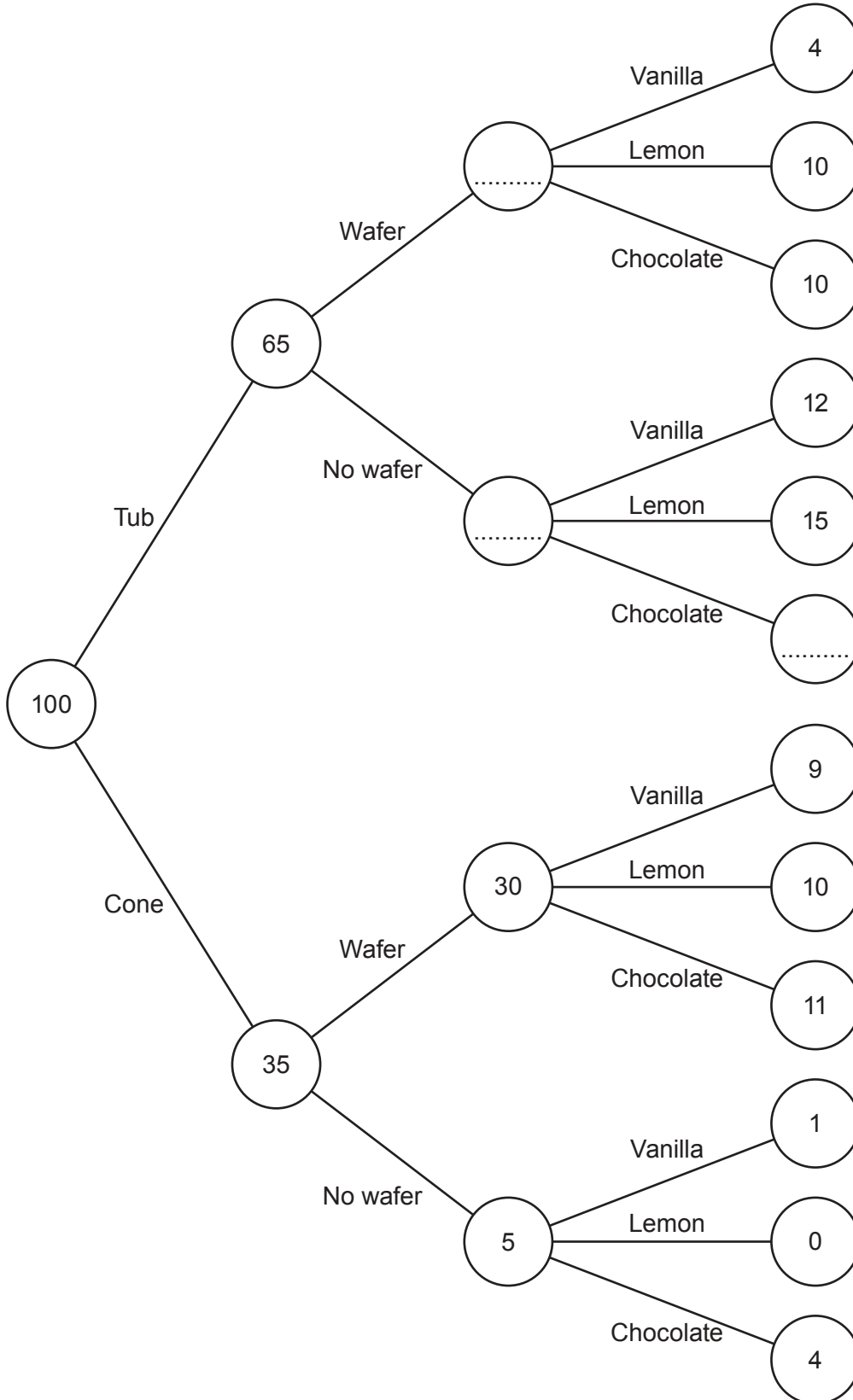

(a) Anaya buys an ice cream.

One choice she can make is

a cone, no wafer and vanilla.

How many different choices can she make?

(a) [1]

(b) Complete the frequency tree. [2]

(c) Which flavour of ice cream was most popular?
Show how you decide.

(c) [3]

12 Solve.

$$4x + 5 = 35$$

$x = \dots\dots\dots$ [2]

13 Delroy drives 240 miles.
His car averages 40 miles per gallon of petrol.
Petrol costs £1.30 per litre.

1 gallon is 4.5 litres.

How much does Delroy spend on petrol for this journey?

£ $\dots\dots\dots$ [4]

- 14** Joan makes cups of tea and coffee at a lunch club.
Each cup requires 250 ml of boiling water.
She has a kettle that boils up to 1.7 litres of water each time.

She boils 10 litres of water in an urn.
She then uses the kettle to boil the rest of the water she needs.

Find the least number of times that Joan needs to boil the kettle to make 56 cups.
Show how you decide.

..... [5]

15 (a) 50 sweets weigh 200 g.

If each sweet weighs the same, work out the weight of 7 sweets.

(a) g [2]

(b) b is directly proportional to a .
 b is 10 when a is 8.

Work out b when a is 9.

(b) $b =$ [2]

(c) A graph is drawn below.

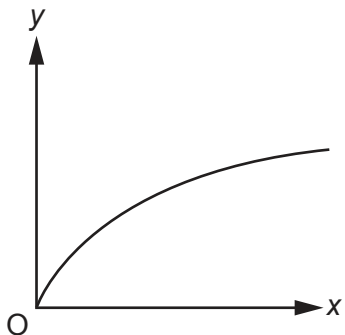

Explain how you know that y is not directly proportional to x .

.....
..... [1]

16 This is the plan view of a 3D object.

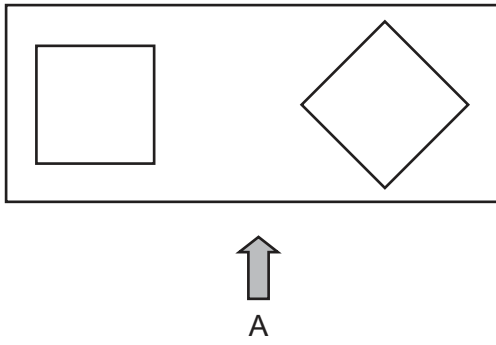

Complete the diagram below to show the front view of the 3D object from A.

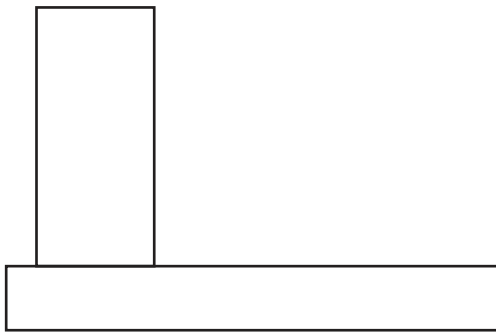

[2]

17 A grain of salt weighs 6.48×10^{-5} kg on average.
A packet contains 0.35 kg of salt.

(a) Use this information to calculate the number of grains of salt in the packet.

(a) [2]

(b) Explain why your answer to part (a) is unlikely to be the actual number of grains of salt in the packet.

.....
.....
..... [1]

18 Tom researches the weights of plant seeds.

- One poppy seed weighs 3×10^{-4} grams.
- 250 pumpkin seeds weigh 21 grams.
- One sesame seed weighs 3.64×10^{-6} kilograms.

Write the three types of seed in order according to the weight of one seed.

Write the lightest type of seed first.

You must show how you decide.

.....,, [4]
lightest

19 (a) This spinner has two grey sections, two white sections and one black section.

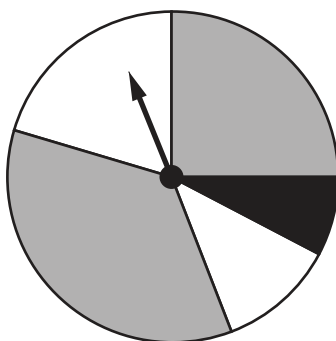

Vlad says

The probability of the spinner landing on black is $\frac{1}{5}$.

Explain why Vlad is not correct.

.....

.....

..... [1]

(b) The graph shows the cost of a litre of petrol for the last six months of 2017.

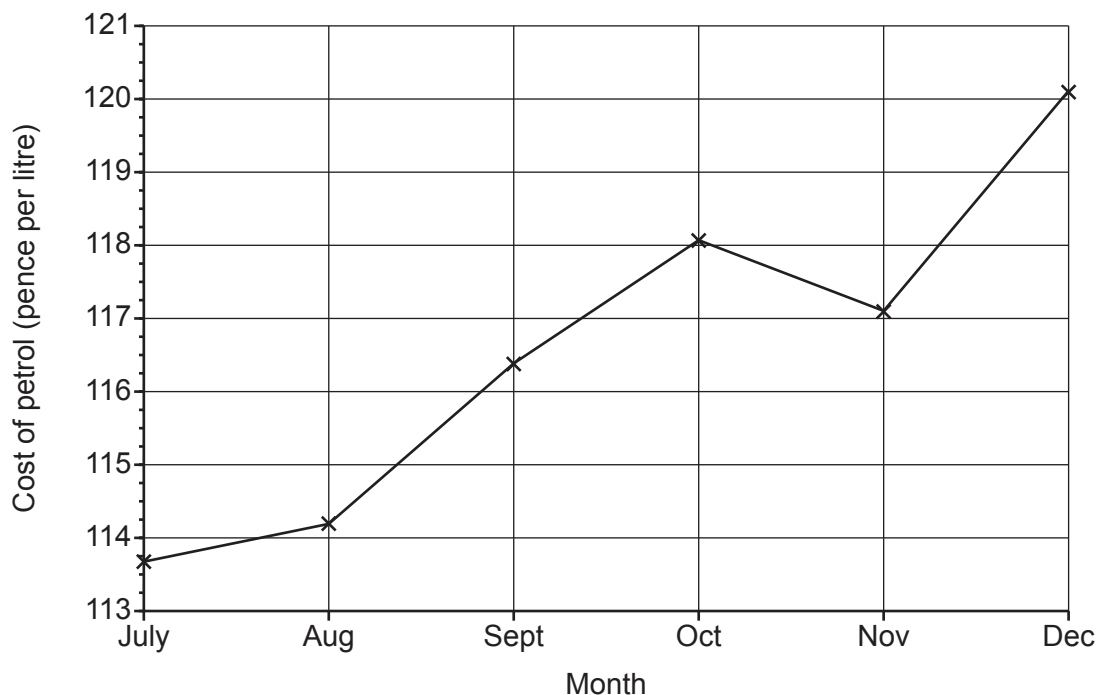

Explain why this graph is misleading.

.....

.....

..... [1]

20 Sophie is organising a raffle.

- Each raffle ticket costs 50p.
- She sells 400 tickets.
- The probability that a ticket, chosen at random, wins a prize is 0.1.
- Each winning ticket receives a prize worth £3.

Sophie says

I expect the raffle to make over £100 profit.

Show that Sophie is wrong.

.....
..... [4]

21 A bag contains some counters.

- There are 300 counters in the bag.
- There are only red, white and blue counters in the bag.
- The probability of picking a blue counter is $\frac{23}{50}$.
- The ratio of red counters to white counters is 2 : 1.

Calculate the number of red counters in the bag.

..... [4]

- 22 Construct the perpendicular from the point P to the line AB.
Show all of your construction lines.

P.

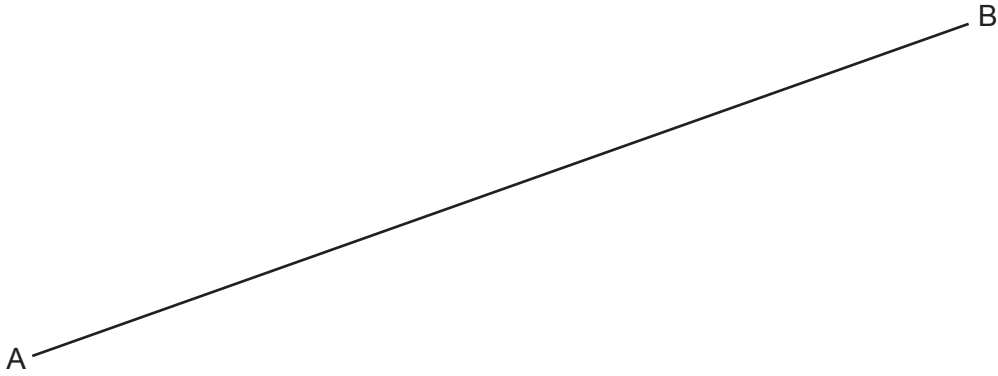

[2]

- 23 The diagram shows a regular hexagon made from six equilateral triangles. Each side is 10 cm. The angle ACB is a right angle.

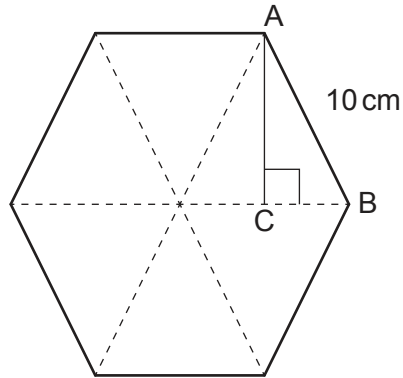

Not to scale

- (a) Show that $AC = 8.66$ cm, correct to 3 significant figures. [4]

- (b) (i) Show that the area of triangle ACB is 21.7 cm^2 , correct to 3 significant figures. [2]

- (ii) Find the area of the hexagon, giving your answer to an appropriate degree of accuracy.

(ii) cm^2 [2]

24 The graph shows two parallel lines, Line A and Line B.

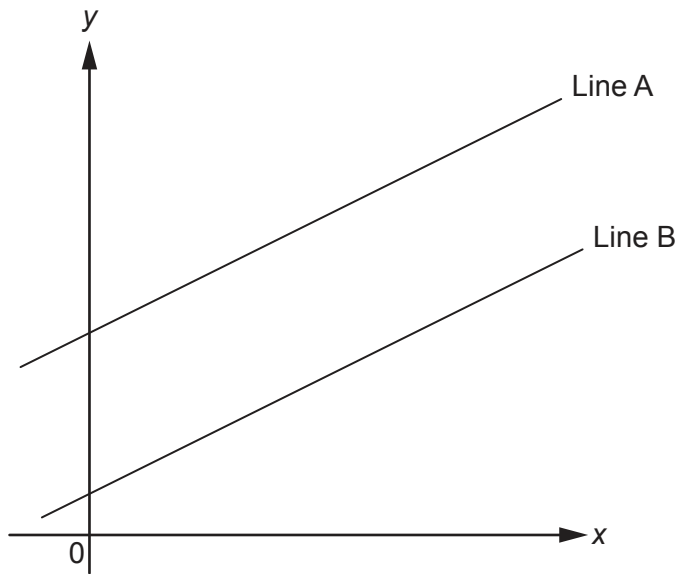

Not to scale

Line A has equation $y = 6x + 7$.
Line B passes through the point $(4, 26)$.

Find the equation of Line B.

..... [4]

25 Are these two triangles mathematically similar?
Show how you decide.

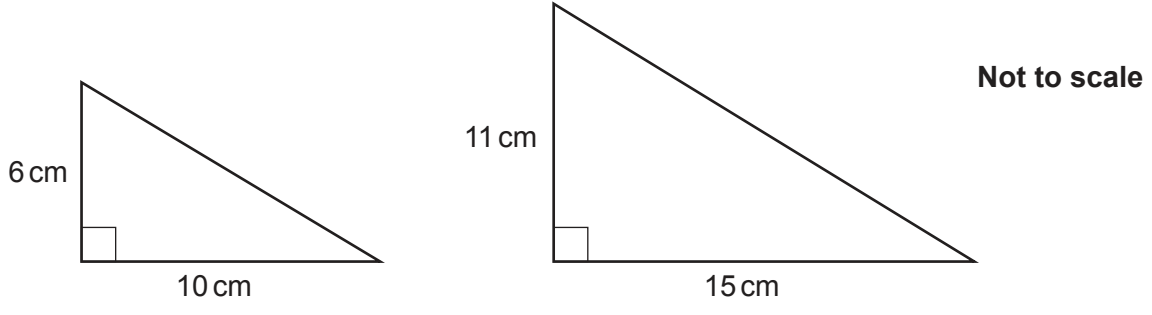

..... because

.....

.....

..... [3]

- 26 (a) A number, g , is given as 4.05, correct to 2 decimal places.

Complete the error interval for g .

(a) $\leq g <$ [2]

- (b) A number, h , is given as 3, truncated to 1 significant figure.

Complete the error interval for h .

(b) $3 \leq h <$ [1]

- 27 Solve by factorising.

$$x^2 + 3x - 10 = 0$$

$x =$ or $x =$ [3]

Turn over for question 28

28 (a) Simplify.

(i) $h^3 \times h^{-3}$

(a) (i) [1]

(ii) $\frac{f^9}{f^3}$

(ii) [1]

(b) The length of each side of a plastic cube is $2a$ millimetres.
The cube has mass $32a^2$ grams.

Find an expression for the density of the cube in its simplest form.
Give the units of your answer.

(b) density =

units [5]

END OF QUESTION PAPER

OCR

Oxford Cambridge and RSA

Copyright Information

OCR is committed to seeking permission to reproduce all third-party content that it uses in its assessment materials. OCR has attempted to identify and contact all copyright holders whose work is used in this paper. To avoid the issue of disclosure of answer-related information to candidates, all copyright acknowledgements are reproduced in the OCR Copyright Acknowledgements Booklet. This is produced for each series of examinations and is freely available to download from our public website (www.ocr.org.uk) after the live examination series.

If OCR has unwittingly failed to correctly acknowledge or clear any third-party content in this assessment material, OCR will be happy to correct its mistake at the earliest possible opportunity.

For queries or further information please contact The OCR Copyright Team, The Triangle Building, Shaftesbury Road, Cambridge CB2 8EA.

OCR is part of the Cambridge Assessment Group; Cambridge Assessment is the brand name of University of Cambridge Local Examinations Syndicate (UCLES), which is itself a department of the University of Cambridge.