

Surname	Centre Number	Candidate Number
First name(s)		0



GCSE

3300U30-1



MONDAY, 14 NOVEMBER 2022 – MORNING

**MATHEMATICS
UNIT 1: NON-CALCULATOR
INTERMEDIATE TIER**

1 hour 45 minutes

ADDITIONAL MATERIALS

The use of a calculator is not permitted in this examination.
A ruler, a protractor and a pair of compasses may be required.

INSTRUCTIONS TO CANDIDATES

Use black ink or black ball-point pen. Do not use gel pen or correction fluid.

You may use a pencil for graphs and diagrams only.

Write your name, centre number and candidate number in the spaces at the top of this page.

Answer **all** the questions in the spaces provided.

If you run out of space, use the additional page at the back of the booklet. Question numbers must be given for all work written on the additional page.

Take π as 3.14.

INFORMATION FOR CANDIDATES

You should give details of your method of solution when appropriate.

Unless stated, diagrams are not drawn to scale.

Scale drawing solutions will not be acceptable where you are asked to calculate.

The number of marks is given in brackets at the end of each question or part-question.

In question 9, the assessment will take into account the quality of your organisation, communication and accuracy in writing.

For Examiner's use only		
Question	Maximum Mark	Mark Awarded
1.	2	
2.	2	
3.	2	
4.	3	
5.	3	
6.	4	
7.	3	
8.	3	
9.	5	
10.	2	
11.	2	
12.	5	
13.	5	
14.	5	
15.	3	
16.	3	
17.	6	
18.	5	
19.	3	
20.	4	
21.	2	
22.	4	
23.	4	
Total	80	



NOV223300U30101

Formula List – Intermediate Tier

Area of trapezium = $\frac{1}{2}(a + b)h$

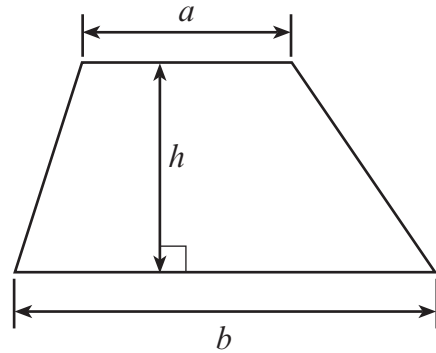

Volume of prism = area of cross-section \times length

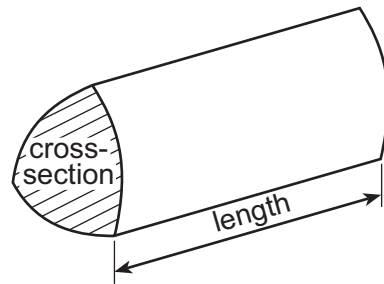

1. Shade the least number of squares so that the grid has rotational symmetry of order 2. The squares you shade must be in the lower two quadrants. [2]

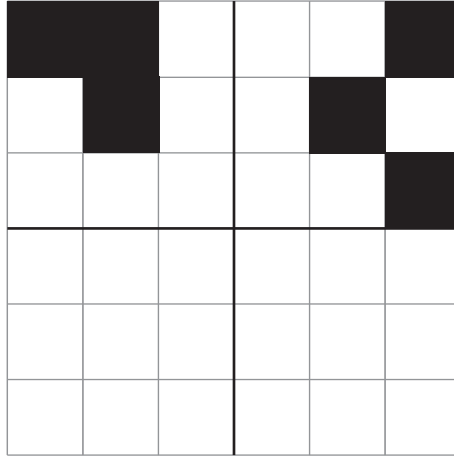

2. Two friends, Geraint and Dyfrig, are having a discussion.



- (a) Geraint says,

"All prime numbers are odd numbers."

Explain why Geraint is incorrect.

[1]

.....

.....

.....

.....

- (b) Dyfrig says,

"All cube numbers are odd numbers."

Explain why Dyfrig is incorrect.

[1]

.....

.....

.....

.....



3. Using only the numbers in the following list,

31 33 35 37 39 41 43

find

(a) the multiple of 5·5, [1]

.....

.....

.....

The multiple of 5·5 is

(b) the factor of 111. [1]

.....

.....

.....

The factor of 111 is



4. A cuboid is to be drawn on the isometric grid below.
 Find a possible length, width and height for the cuboid, such that:
- the cuboid has a volume of 12 cm^3
 - each of the length, width and height is a whole number of centimetres.

Write the length, width and height of your cuboid in the spaces below.
 Use the grid below to draw an isometric representation of your cuboid.

[3]

.....

.....

.....

Length = cm Width = cm Height = cm

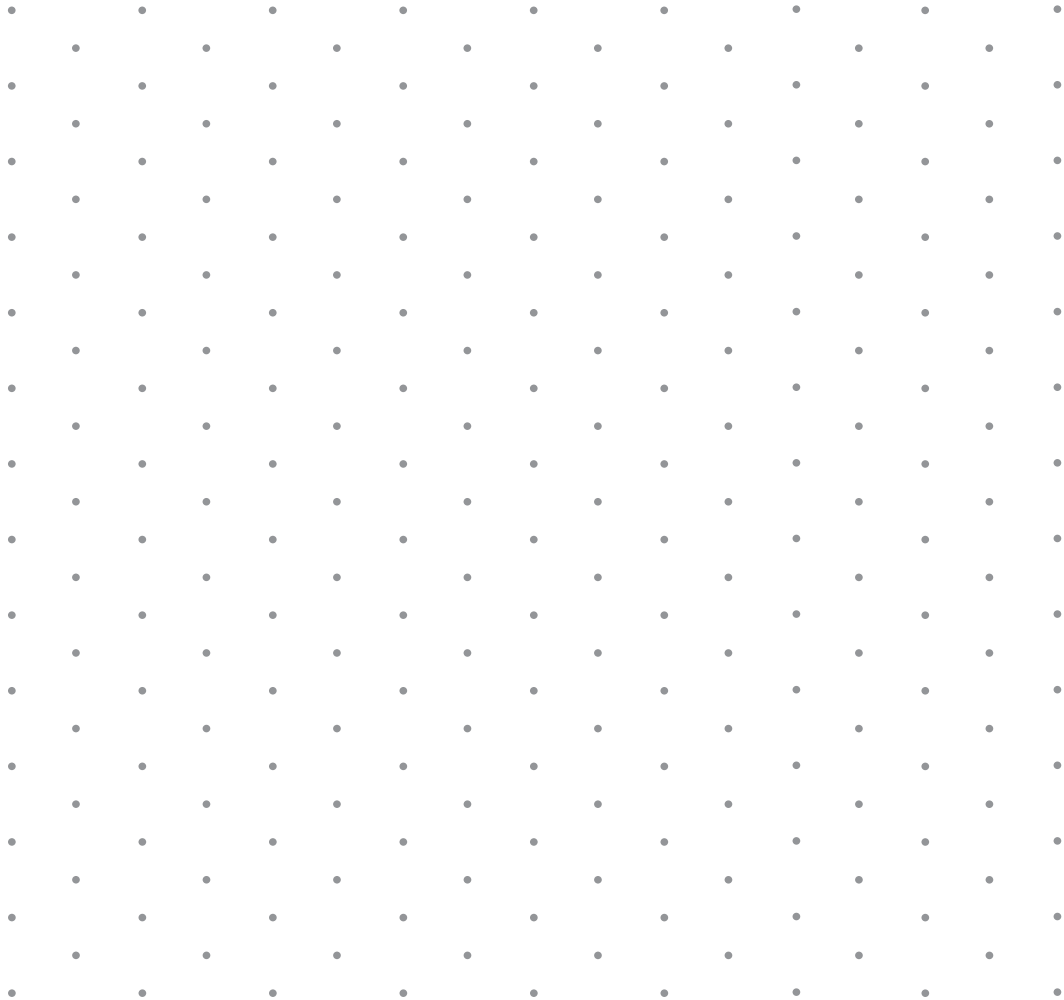

3300U301
05



5. Andrew and Grace each have some £10 notes and £5 notes.
Andrew has 6 notes. The total value of Andrew's notes is £55.
Grace has 5 notes. The total value of Grace's notes is £35.

How many £10 notes do they have in total?
How many £5 notes do they have in total?

[3]

.....

.....

.....

.....

.....

.....

.....

.....

.....

.....

Total number of £10 notes = Total number of £5 notes =

6. (a) Solve the equation $7p - 3 = 60$.

[2]

.....

.....

.....

.....

.....

.....

- (b) Simplify the expression $6a - 7b - 2a - 8b$.

[2]

.....

.....

.....



8. There are five numbers in a list.
The mean of the five numbers is 7.
Another number is added to the list.
The mean of these six numbers is 8.5.

Find the value of the sixth number.
You must show all your working.

[3]

.....

.....

.....

.....

.....

.....

.....

.....

9. *In this question, you will be assessed on the quality of your organisation, communication and accuracy in writing.*

A sum of money is shared in the ratio 1 : 8.
The **larger** share is £16.80.
What is the total amount of money shared?
You must show all your working.

[3 + 2 OCW]

.....

.....

.....

.....

.....

.....

.....

.....

.....

.....

.....

.....

.....

.....

.....

.....

.....

.....

.....

.....



10. Estimate the value of $\frac{20 \cdot 4 \times 59 \cdot 1}{407}$.

You must show all your working.

[2]

.....

.....

.....

.....

.....

.....

11. The n th term of a sequence is given by $3n - 13$.

Write down the value of

(a) the 10th term,

[1]

.....

.....

.....

(b) the 4th term.

[1]

.....

.....

.....



12. Samira has a dice. Its faces are numbered 1 to 6. She wants to know whether her dice is biased or not. Samira rolled this dice 300 times. Her results are shown in the table below.

Number shown on dice	1	2	3	4	5	6
Frequency	65	40	52	10	23	110

- (a) The relative frequency of throwing a 5 is $\frac{23}{300}$.

What is the relative frequency of throwing a 2?
Give your answer as a fraction in its simplest form.

[2]

.....

.....

.....

- (b) Do the results in the table suggest that Samira's dice is biased?

Yes

No

Explain your decision.

[1]

.....

.....

.....

.....

- (c) This dice is thrown 2400 times.
Use Samira's results to calculate the number of times you would expect a 6 to be thrown.

[2]

.....

.....

.....

.....

.....

.....



14. In a group of 200 people:

- 105 people do not have black hair and do not wear glasses
- 20 people have black hair and wear glasses
- 70 people have black hair.

(a) Complete the Venn diagram below to show this information.
The universal set, \mathcal{E} , contains all 200 people.

[3]

.....

.....

.....

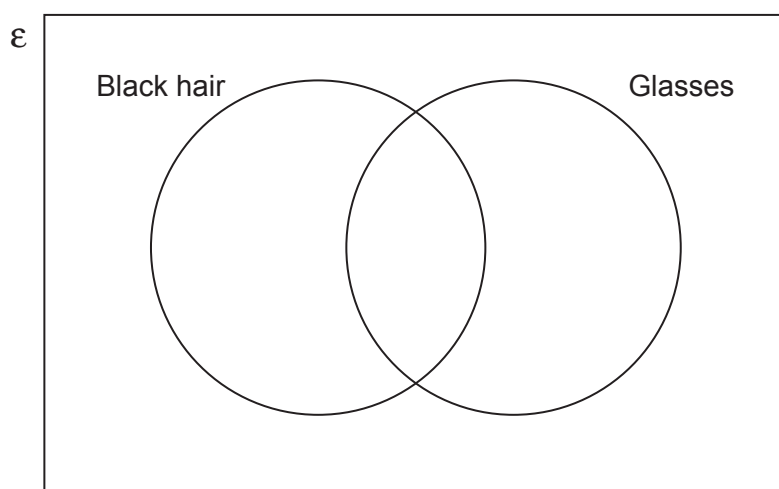

(b) One of these people is chosen at random.
What is the probability that this person wears glasses?

[2]

.....

.....

.....

.....



15. Triangle ABC is shown in the diagram below.
Using only a ruler and a pair of compasses, construct an accurate drawing of triangle ABC .
Side AC has been drawn for you.
All construction lines and arcs must be shown. [3]

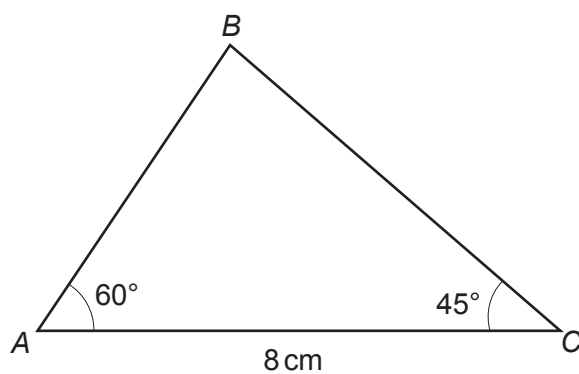
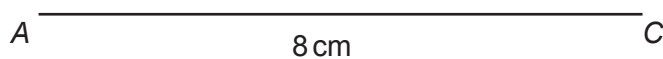

Diagram not drawn to scale



16. Express 1575 as a product of its prime factors in index form.

[3]

.....

.....

.....

.....

.....

.....

.....

.....

.....

.....

.....

.....

.....

.....

.....

.....



17. Simplify the following expressions.

(a) $2p^3q \times 3p^4q^7$ [2]

.....
.....

(b) $7a(a+5) - 2(3a^2 + 6a - 7)$ [4]

.....
.....
.....
.....
.....
.....
.....
.....
.....



18. The diagram below shows the graph of a straight line for values of x from -1 to 3 .

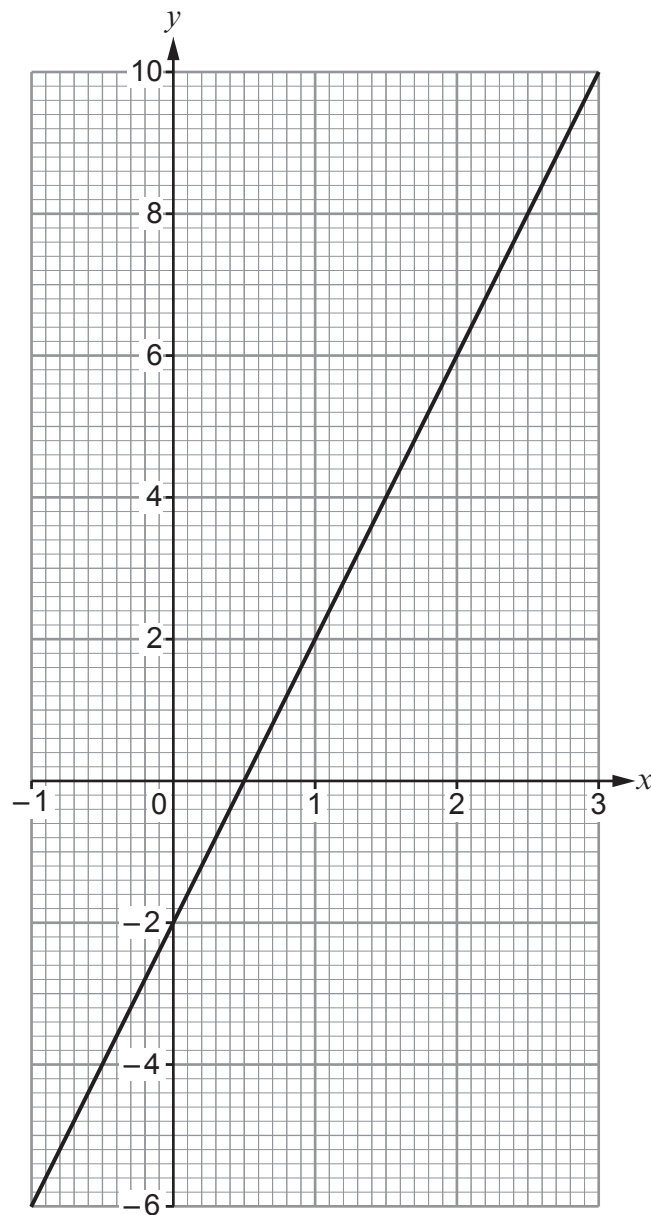

(a) (i) Write down the gradient of the line above.

[1]

.....

.....



(ii) Write down the equation of the line in the form $y = mx + c$.

[2]

.....

.....

(b) Show that the lines

$$y = 3x - 8 \quad \text{and} \quad 2y - 6x = 23$$

are parallel to each other.

[2]

.....

.....

.....

.....

.....

.....

.....

.....

.....



- 19.** In the following formulae, each measurement of length is represented by a letter. Consider the dimensions implied by each formula. For each case, write down whether the formula could be for a length, an area, a volume or none of these.

The first one has been done for you.

[3]

<u>Formula</u>	<u>Formula could be for</u>
$7a^3 - abc$	volume
$7ab - 5b^2 + \frac{a^2b}{c}$
$5abc - 6bc + b^2$
$4a^2b + 4b^2a$
$3a + 8b + 2c$
$a^2 - abc$



20. (a) Calculate the value of $(3 \times 10^4) \div (6 \times 10^{-3})$.
Give your answer in standard form.

[2]

.....

.....

.....

.....

.....

.....

- (b) Calculate the value of $(4.78 \times 10^4) + (1.5 \times 10^2)$.
Give your answer in standard form.

[2]

.....

.....

.....

.....

.....

.....



21. (a) Which complete method, using Pythagoras's Theorem, can be used to find x ?
Circle your answer.

[1]

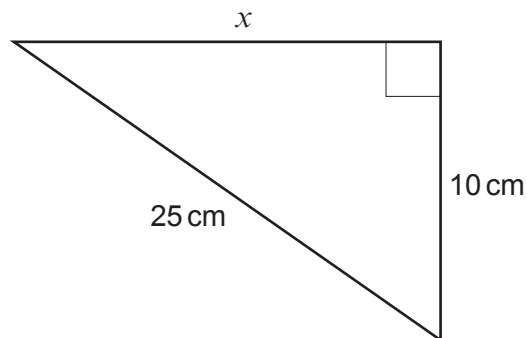

Diagram not drawn to scale

$$x = 25^2 + 10^2$$

$$x = \sqrt{25^2 + 10^2}$$

$$x = 25^2 - 10^2$$

$$x = \sqrt{25^2 - 10^2}$$

$$x = \sqrt{(25 - 10)^2}$$

- (b) Which of the following calculations can be used to find y ?
Circle your answer.

[1]

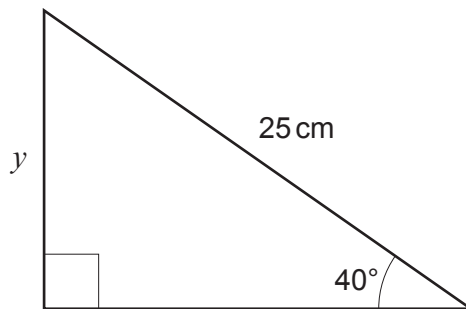

Diagram not drawn to scale

$$\sin 25^\circ = y \times 40$$

$$\sin 40^\circ = \frac{25}{y}$$

$$\sin 25^\circ = \frac{y}{40}$$

$$\sin 40^\circ = \frac{y}{25}$$

$$\sin 40^\circ = y \times 25$$



BLANK PAGE

**PLEASE DO NOT WRITE
ON THIS PAGE**

