

Surname
Other Names

Centre Number

Candidate Number
0



GCSE – NEW

3300U60-1



**MATHEMATICS
UNIT 2: CALCULATOR-ALLOWED
HIGHER TIER**

TUESDAY, 20 JUNE 2017 – AFTERNOON

1 hour 45 minutes

ADDITIONAL MATERIALS

A calculator will be required for this paper.
A ruler, a protractor and a pair of compasses may be required.

INSTRUCTIONS TO CANDIDATES

Use black ink or black ball-point pen. Do not use gel pen or correction fluid.
You may use a pencil for graphs and diagrams only.
Write your name, centre number and candidate number in the spaces at the top of this page.
Answer **all** the questions in the spaces provided.
If you run out of space, use the continuation page(s) at the back of the booklet, taking care to number the question(s) correctly.
Take π as 3.14 or use the π button on your calculator.

INFORMATION FOR CANDIDATES

You should give details of your method of solution when appropriate.
Unless stated, diagrams are not drawn to scale.
Scale drawing solutions will not be acceptable where you are asked to calculate.
The number of marks is given in brackets at the end of each question or part-question.
In question 11, the assessment will take into account the quality of your linguistic and mathematical organisation, communication and accuracy in writing.

For Examiner's use only		
Question	Maximum Mark	Mark Awarded
1.	4	
2.	5	
3.	4	
4.	3	
5.	3	
6.	3	
7.	5	
8.	5	
9.	2	
10.	2	
11.	7	
12.	5	
13.	5	
14.	3	
15.	3	
16.	5	
17.	1	
18.	5	
19.	2	
20.	4	
21.	4	
Total	80	



JUN173300U60101

Formula List - Higher Tier

Area of trapezium = $\frac{1}{2}(a + b)h$

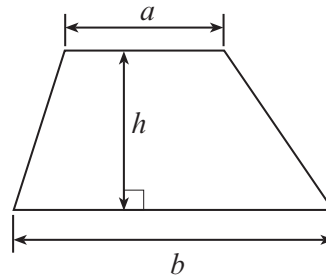

Volume of prism = area of cross-section \times length

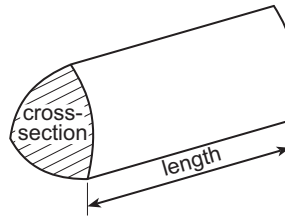

Volume of sphere = $\frac{4}{3}\pi r^3$

Surface area of sphere = $4\pi r^2$

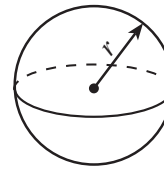

Volume of cone = $\frac{1}{3}\pi r^2 h$

Curved surface area of cone = $\pi r l$

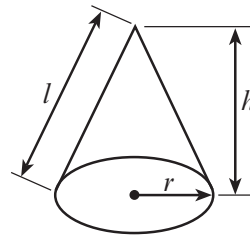

In any triangle ABC

Sine rule $\frac{a}{\sin A} = \frac{b}{\sin B} = \frac{c}{\sin C}$

Cosine rule $a^2 = b^2 + c^2 - 2bc \cos A$

Area of triangle = $\frac{1}{2} ab \sin C$

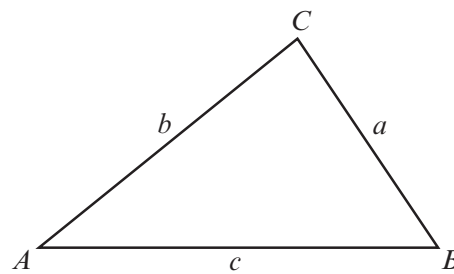

The Quadratic Equation

The solutions of $ax^2 + bx + c = 0$ where $a \neq 0$ are given by $x = \frac{-b \pm \sqrt{(b^2 - 4ac)}}{2a}$

Annual Equivalent Rate (AER)

AER, as a decimal, is calculated using the formula $\left(1 + \frac{i}{n}\right)^n - 1$, where i is the nominal interest rate per annum as a decimal and n is the number of compounding periods per annum.



4. A right-angled triangle LMN is shown below.
 $LN = 16.9$ cm and $LM = 6.5$ cm.

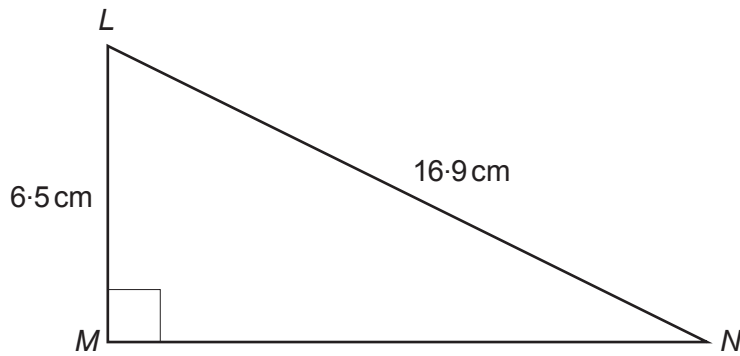

Diagram not drawn to scale

Calculate the length MN .

[3]

.....

.....

.....

.....

.....

.....

.....

.....

.....

.....



5. Construct an accurate drawing of triangle ABC , where $AB = 7$ cm, $\hat{A}BC = 90^\circ$ and $\hat{B}AC = 60^\circ$.
Use only a ruler and a pair of compasses.
The side AB has been drawn for you.
You must show your construction arcs.

[3]



6. Calculate the length of the side QR in the triangle PQR shown below. [3]

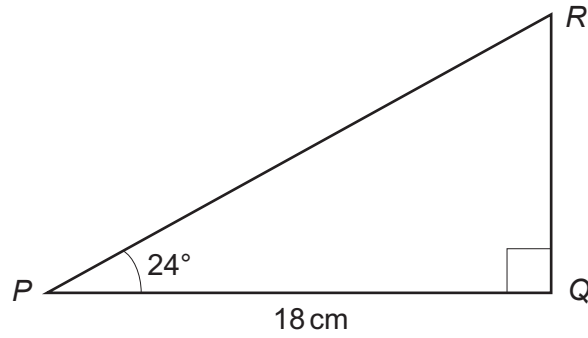

Diagram not drawn to scale

.....

.....

.....

.....

.....

.....

.....

.....

.....

.....

.....

.....

.....

.....

.....

.....

.....

.....

.....

.....

.....

.....

3300U601
07

- (c) If a large number of people played the game, approximately what fraction of them would you expect to choose a white ball?
Circle your answer. [1]

$\frac{1}{10}$

$\frac{1}{5}$

$\frac{1}{4}$

$\frac{1}{3}$

$\frac{1}{2}$

.....

.....

8. (a) Factorise $x^3 - 5x$. [1]

.....

- (b) Expand and simplify $(2x - 3)(x + 4)$. [2]

.....

.....

.....

- (c) Factorise $x^2 - 3x - 28$. [2]

.....

.....

.....



9. (a) Circle the equation of a straight line that is parallel to the line $3y = 2x + 6$. [1]

$3y = 2x + 7$

$2y = 3x + 6$

$3y = -2x + 6$

$-3y = 2x + 6$

$2y = -3x + 6$

.....
.....

(b) Circle the equation of a straight line that is perpendicular to the line $y = 5x - 3$. [1]

$y = \frac{x}{5} + 3$

$y = 5x + 3$

$y = 5x + \frac{1}{3}$

$y = -5x + 3$

$y = \frac{-x}{5} + 3$

.....



10. Points A , B and C lie on the circumference of a circle, centre O .
 $\hat{ACB} = 37^\circ$.

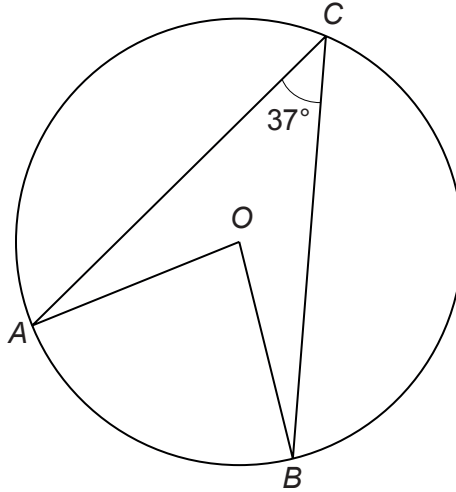

Diagram not drawn to scale

Calculate the size of the **reflex** angle \hat{AOB} .

[2]

.....

.....

.....



12. Make c the subject of the following formula.
Give your answer in its simplest form.

[5]

$$c - 5 = \frac{3c - 7}{d}$$

.....

.....

.....

.....

.....

.....

.....

.....

.....

.....

.....

.....

.....

.....

.....

.....

.....

.....

.....

.....

.....

.....

.....



14. The region between two rectangles is shaded, as shown in the diagram below. All of the measurements shown are given **correct to the nearest cm**.

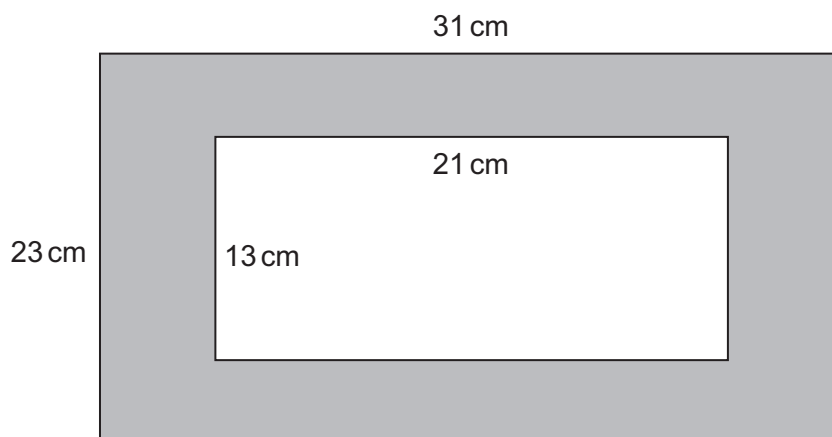

Diagram not drawn to scale

Calculate the greatest possible area of the shaded region.

[3]

.....

.....

.....

.....

.....

.....

.....



15. Describe fully a **single** transformation that transforms shape A onto shape B.

[3]

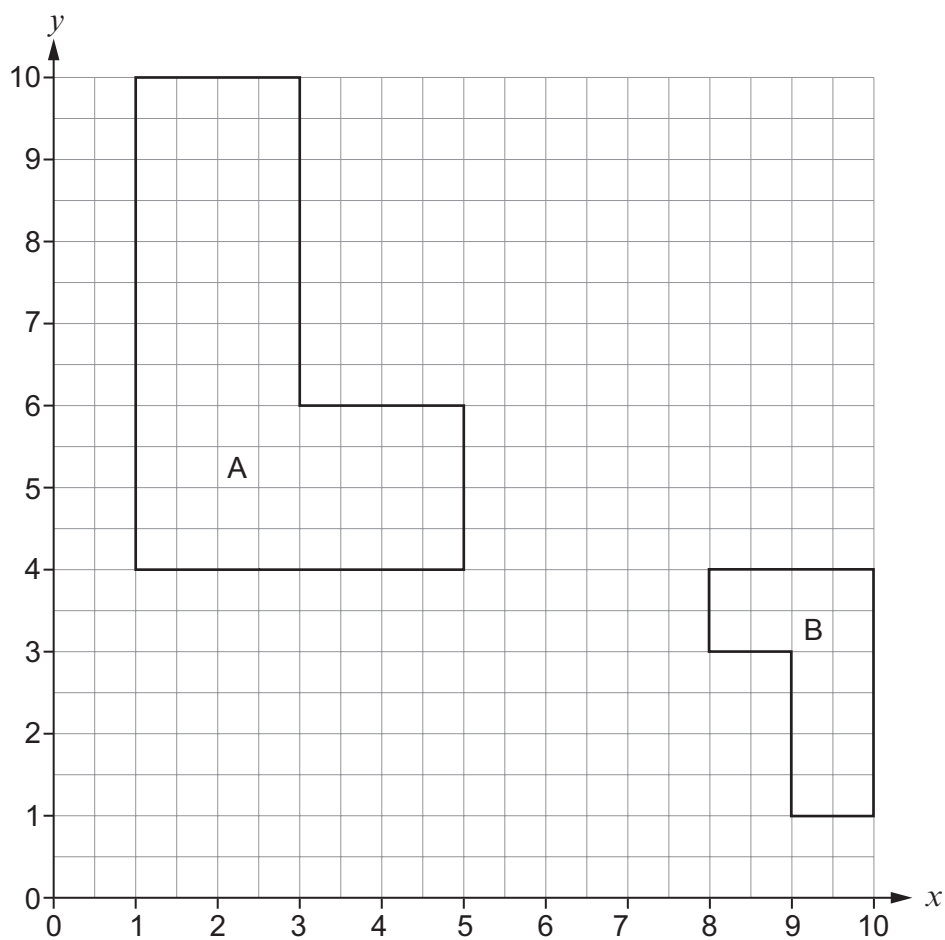

.....

.....

.....

.....

.....

.....

.....

.....

.....



16. The table below shows the three-day rain forecast for Monday, Tuesday and Wednesday in Eglwysrwrw.

Day	Probability of rain
Monday	80%
Tuesday	80%
Wednesday	80%

For these three days,

- (a) calculate the probability that it will rain on all three days. [2]

.....

.....

.....

.....

.....

.....

.....

.....

- (b) calculate the probability that it will rain on exactly 2 consecutive days. [3]

.....

.....

.....

.....

.....

.....

.....

.....



19. (a) Give one example to show that the square of an irrational number is **not** always rational. [1]

.....

.....

.....

.....

.....

.....

Number = Square of the number =

- (b) Find two **different** irrational numbers to make the answer to the calculation below rational. Complete the calculation by filling in the three boxes. [1]

$$\square \times \square = \square$$

.....

.....

.....

.....

.....

.....



20. A sketch of the graph $y = f(x)$ is shown below.
Two specific points are shown on the graph. They are called a maximum point and a minimum point.
The maximum point shown is $(-2, 2)$ and the minimum point shown is $(2, -2)$.

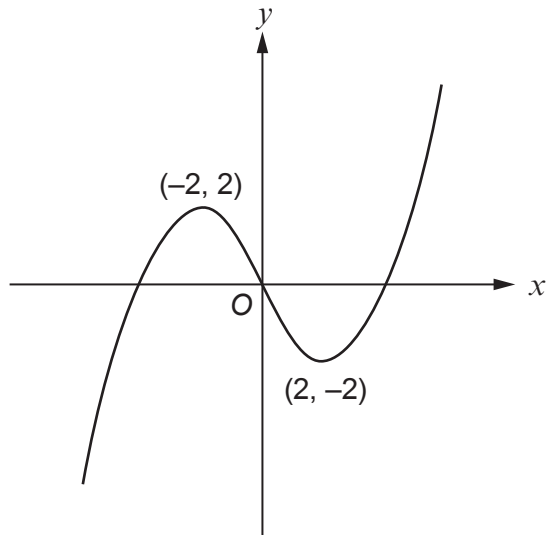

The graphs on the opposite page are transformations of $y = f(x)$.
Draw a line connecting each graph to the equation describing the transformation.
One has been done for you.

[4]



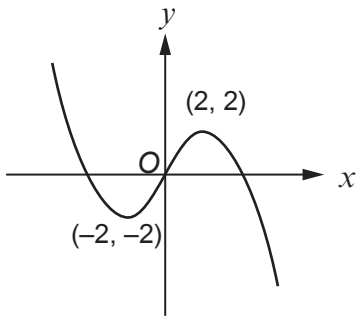

$$y = f(x) - 2$$

$$y = f(x + 2)$$

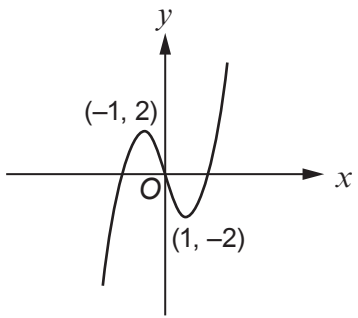

$$y = -f(x)$$

$$y = 2f(x)$$

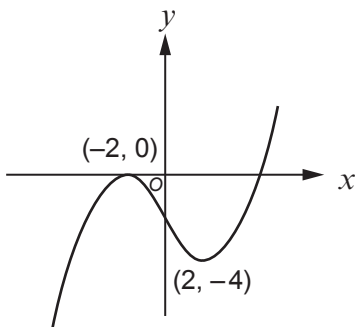

$$y = f(2x)$$

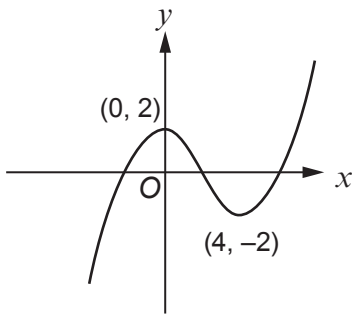

$$y = f(x) + 2$$

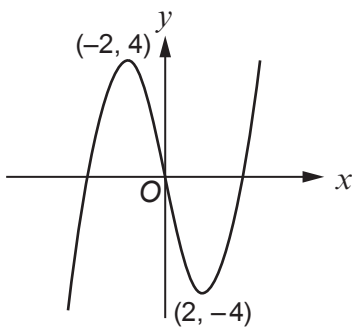

$$y = \frac{1}{2} f(x)$$

$$y = f(x - 2)$$



21. The cube below has an internal diagonal of length 20 cm.
Each edge of the cube is of length x cm.

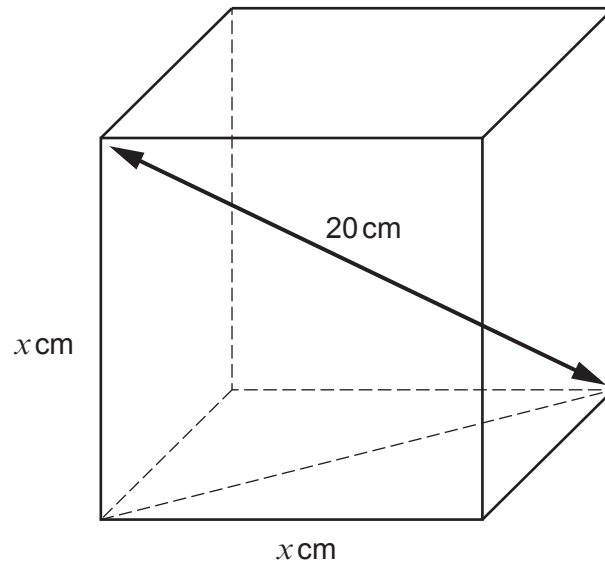

Diagram not drawn to scale

Calculate the value of x .
You must use an algebraic method and show all your working.

[4]

.....

.....

.....

.....

.....

.....

.....

.....

.....

.....

.....

END OF PAPER



BLANK PAGE

**PLEASE DO NOT WRITE
ON THIS PAGE**



